

Grade 2 Lever Locks 800 Series

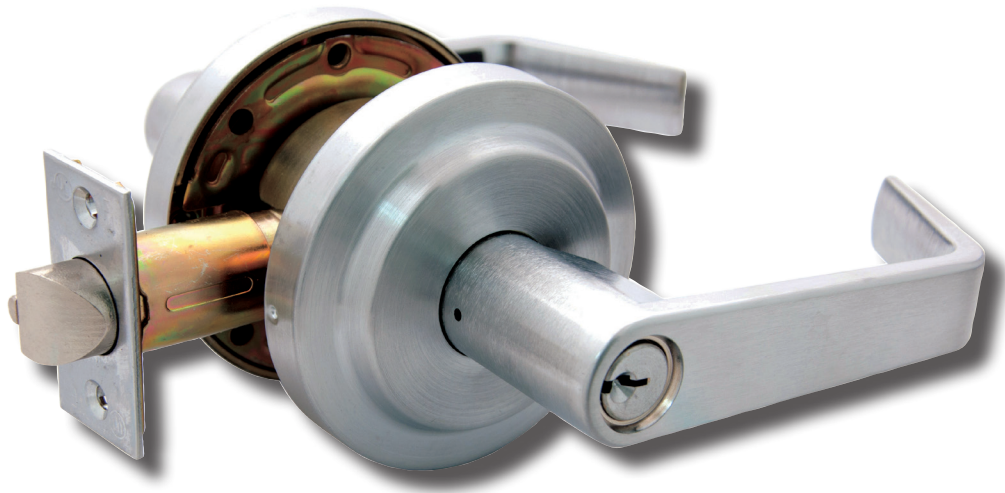

Overview

The 800 Series locks are designed for use in a variety of commercial applications. Equipped with a U.L. listed latchbolt, these locks can be used on 3-Hour fire doors. Built with independent return springs in each lever and with an optional clutch feature to protect against excessive torque, these levers resist sagging. The L-shaped lever design with less than 1/2" gap between the handle and the door meets most accessibility codes.

Compliance

- ANSI/BHMA 156.2 Series 4000, Grade 2
- Latch is UL Listed (USA and Canada) for 3-hour fire doors, included; UL10C /UBC 7-2 positive pressure
- ADA: The Americans With Disabilities Act (ADA) states that locks shall be operable with one hand and shall not require tight grasping, tight pinching or twisting of the wrist.

Applications

- Offices
- Commercial Properties
- Retail Spaces
- Multi-Family Buildings



Grade 2 Lever Locks, 800 Series

Standard Features:

Latch	2¾" Backset UL listed included; 2¾" Backset UL Listed available
Handing	Non-Handed
Materials	Zinc Alloy, Bronze, Brass or Stainless Steel
Strike	4⅞" x 1¼" ANSI
Door Prep	2⅛" diameter bore, 1" crossbore
Door Thickness	1⅜" - 2", Optional Thru Bolts
Rose Diameter	3⅜"
Keying	Cylinders: Equipped with SC4 rekeyable 6-pin brass cylinders, compatible with LSDA replacement C500 cylinders and many other retrofit cylinders including most high security brands. SFIC: Some models prepped for Small Format Interchangeable Core (SFIC), such as 6- or 7-Pin Best® style cores

Designs

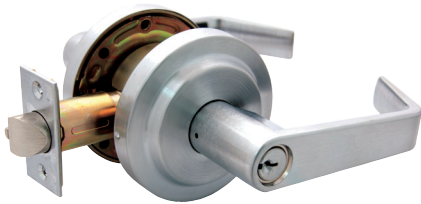

Vancouver (VA), Step Rose
Entrance Function
Shown in 26D Finish

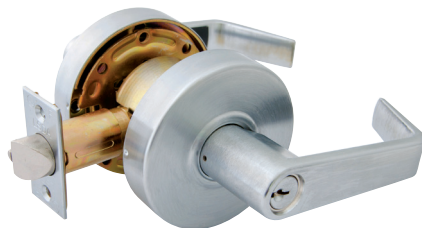

Edmonton (ED), Flat Rose
Entrance Function
Shown in 26D Finish

Grade 2 Lever Locks, 800 Series

Functions

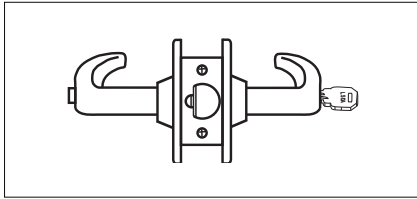

Entrance/Office

Pushing and turning inside button locks outside lever requiring use of key until button is manually unlocked. Pushing inside button locks outside lever until unlocked with a key or inside lever is turned. Inside lever always retracts latch. Available with or without Clutch.

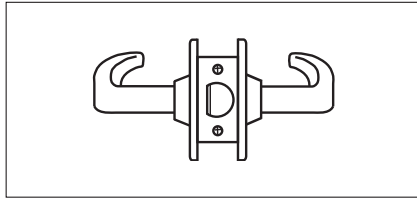

Passage

Both levers always retract the latch

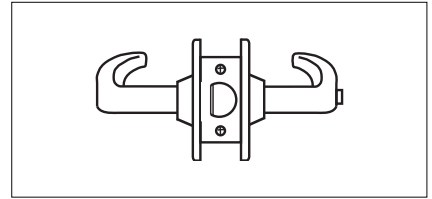

Privacy

Pushing inside button locks outside lever until inside lever is turned. Emergency tool can be used to unlock outside lever. Inside lever always retracts the latch.

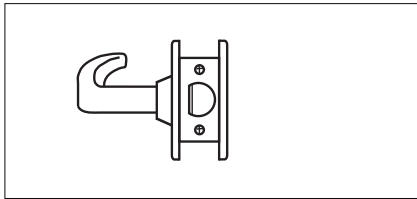

Exit

Blank plate outside, inside lever always free

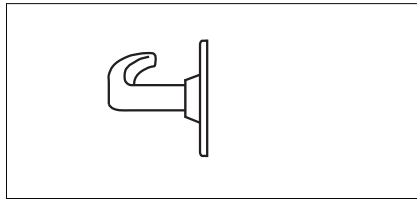

Dummy

Pull only, one side of door trim.

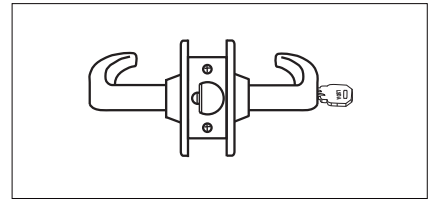

Storeroom

Outside lever never retracts the latch. Entrance by key only. Inside lever always retracts the latch. Available with or without Clutch.

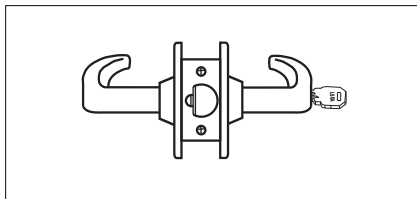

Classroom

Outside lever is locked and unlocked with a key in the outside cylinder. The inside lever always retracts the latch. Available with or without Clutch.

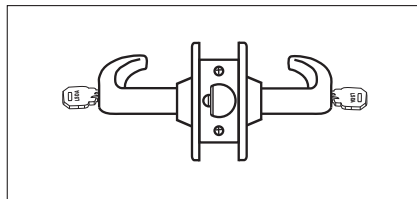

Communicating

Key in either lever locks or unlocks the lever.

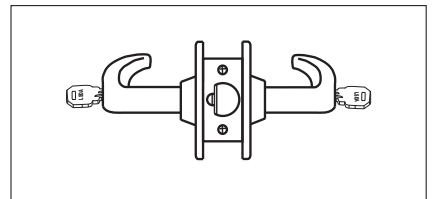

Institutional

Neither lever/knob retracts the latch. A key is required in both the inside and outside cylinder to retract the latch. Available with or without Clutch.

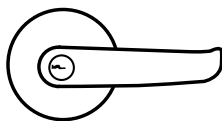

Benefits of a Clutch Lever

Clutch mechanism, or "free-wheeling" design offers an advantage over rigid locked leversets by reducing the torque applied to the outside lever

Grade 2 Lever Locks, 800 Series

How to Order

Entrance/Office with Clutch

Calgary Design

Mfr.#	Keyway	Latch	EZ#
C800CA26D SC4 2-3/4UL	SC4	2¾" UL	107681

Vancouver Design

Mfr.#	Keyway	Latch	EZ#
C800VA3LC2-3/4UL	L/Cyl.	2¾" UL	105663
C800VA26D LC2-3/4UL	L/Cyl.	2¾" UL	105659
C800VA26D SC4 2-3/4UL	SC4	2¾" UL	105661
C800VA3SC4 2-3/4UL	SC4	2¾" UL	105662
C800VA26D IC2-3/4UL	SFIC, L/Cyl	2¾" UL	103428

Edmonton Design

Mfr.#	Keyway	Latch	EZ#
C800ED26D SC4 2-3/4UL	SC4	2¾" UL	105660
C800ED19S2-3/4UL	SC4	2¾" UL	184405

Passage

Calgary Design

Mfr.#	Latch	EZ#
810CA26D2-3/4UL	2¾" UL	107682

Vancouver Design

Mfr.#	Latch	EZ#
810VA26D2-3/4UL	2¾" UL	103429
810VA3 2-3/4UL	2¾" UL	105666

Edmonton Design

Mfr.#	Latch	EZ#
810ED26D2-3/4UL	2¾" UL	105665
810ED19 2-3/4UL	2¾" UL	184406

Privacy

Calgary Design

Mfr.#	Latch	EZ#
820CA26D2-3/4UL	2¾" UL	107683

Vancouver Design

Mfr.#	Latch	EZ#
820VA26D2-3/4UL	2¾" UL	103430
820VA3 2-3/4UL	2¾" UL	105668

Edmonton Design

Mfr.#	Latch	EZ#
820ED26D2-3/4UL	2¾" UL	105667
820ED19 2-3/4UL	2¾" UL	184407

Storeroom with Clutch

Calgary Design

Mfr.#	Keyway	Latch	EZ#
C840CA26D SC4 2-3/4UL	SC4	2¾" UL	107684

Vancouver Design

Mfr.#	Keyway	Latch	EZ#
C840VA26D LC2-3/4UL	L/Cyl.	2¾" UL	105777
C840VA26D IC2-3/4UL	SFIC, L/Cyl.	2¾" UL	103432
C840VA26D SC4 2-3/4UL	SC4	2¾" UL	105672
C840VA3SC4 2-3/4UL	SC4	2¾" UL	105673

Edmonton Design

Mfr.#	Keyway	Latch	EZ#
C840ED26DSC4 2-3/4UL	SC4	2¾" UL	105671
C840ED19S2-3/4UL	SC4	2¾" UL	184408

Continued on the Next Page

Grade 2 Lever Locks, 800 Series

How to Order (Cont'd)

Classroom with Clutch

Calgary Design

Mfr.#	Keyway	Latch	EZ#
C850CA26D SC4 2-3/4UL	SC4	2¾" UL	108517

Vancouver Design

Mfr.#	Keyway	Latch	EZ#
C850VA26D SC4 2-3/4UL	SC4	2¾" UL	105677

Exit

Vancouver Design

Mfr.#	Latch	EZ#
830VA26D2-3/4UL	2¾" UL	105669

Dummy

Vancouver Design

Mfr.#	EZ#
860VA26D	181762

Communicating

Vancouver Design

Mfr.#	Keyway	Latch	EZ#
870VA26D SC4 2-3/4UL	SC4	2¾" UL	105675

Institutional

Vancouver Design

Mfr.#	Keyway	Latch	EZ#
890VA26D SC4 2-3/4UL	SC4	2¾" UL	105678

Dimensions

Calgary (CA)

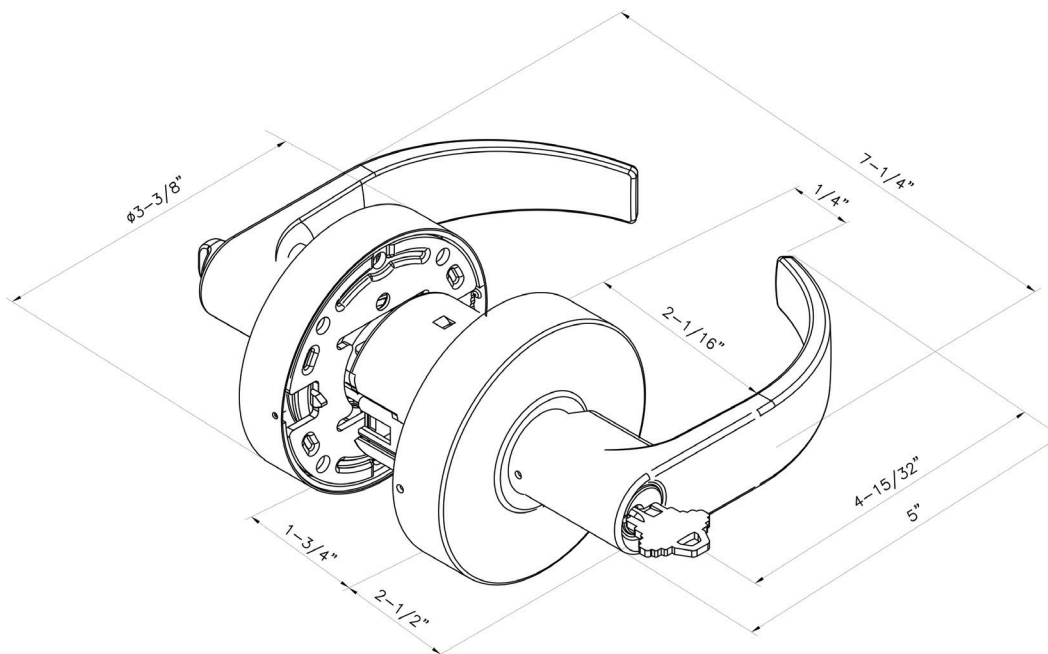

Grade 2 Lever Locks, 800 Series

Dimensions

Vancouver (VA)

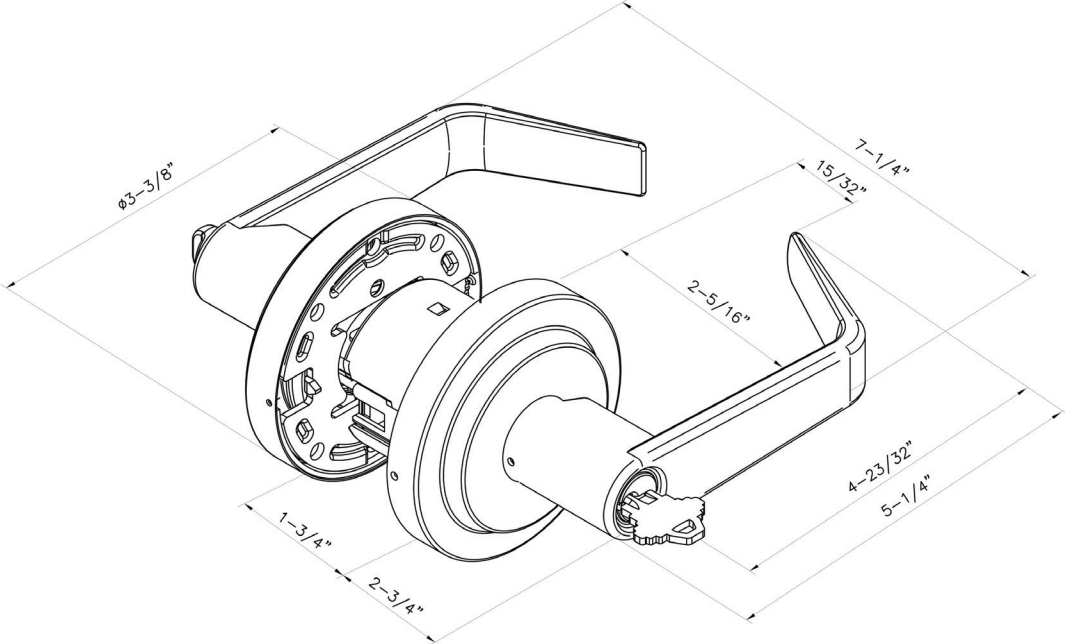

Edmonton (ED)

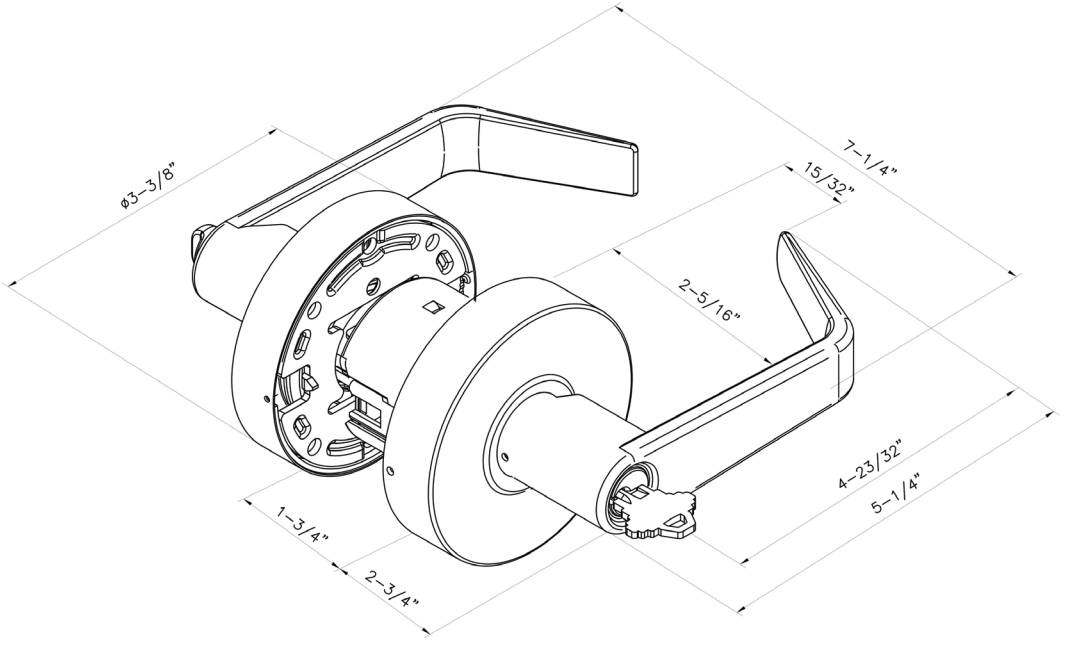

Grade 2 Lever Locks, 800 Series

Parts and Accessories

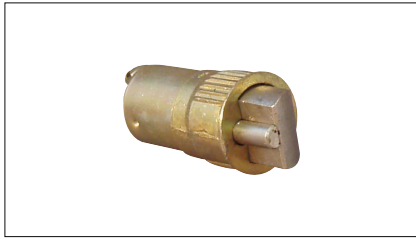

L105

- Drive-In Latch
- 2¾" Backset
- With Round Face Latch. Sold without Faceplate
- Finishes: US3, US32D

Mfr.#	EZ#
L105 32D	009334



L104

- Drive-In Latch
- 2¾" Backset
- With Round Face Latch. Sold without Faceplate
- Finishes: US32D

Mfr.#	EZ#
L104 32D	009333



L014

- Springlatches, 2¾" Backset
- UL Listed (Where Indicated)
- Faceplate: 1½" x 2¼"
- Finishes: US32D

Mfr.#	EZ#
L014UL32D	083877



L085

- Deadlatches, 2¾" Backset
- UL Listed (Where Indicated)
- Faceplate: 1" x 2¼"
- Finishes: US3, US26D

Mfr.#	EZ#
L085UL26D	005570
L085UL3	005571



L096

- Deadlatches, 2¾" Backset
- UL Listed (Where Indicated)
- Faceplate: 1½" x 2¼"
- Finishes: US3, US26D

Mfr.#	EZ#
L096UL3	005574
L096UL26D	005573



L005

- Springlatches, 2¾" Backset
- UL Listed (Where Indicated)
- Faceplate: 1" x 2¼"
- Finishes: US3, US26D

Mfr.#	EZ#
L005UL3	086726
L005UL26D	086727

Grade 2 Lever Locks, 800 Series

Parts and Accessories



EL5

- 5" extension link for 2 $\frac{3}{4}$ " latch

Mfr.#	EZ#
EL5	028533

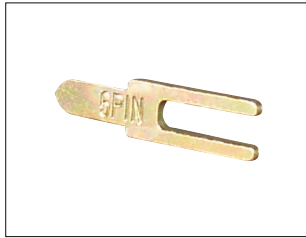

TPSFIC6

- IC Tailpiece
- 6-Pin

Mfr.#	EZ#
TPSFIC6	061315

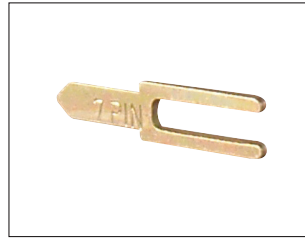

TPSFIC7

- IC Tailpiece
- 7-Pin

Mfr.#	EZ#
TPSFIC7	061316

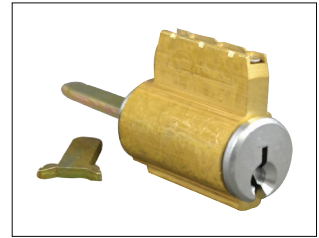

CYL

- Key-in-Knob (KIK) Cylinder
- Drilled 6-Pin, Pinned 5-Pin
- Keyway: SC1 (C)
- Finishes: US26D
- Keyed Alike: KA2 where indicated

Mfr.#	EZ#
CYL C26D KA2	084143

Grade 2 Lever Locks, 800 Series

Finishes

US3 / 505 / 605
Bright Brass



10BE / 613E
Dark Oxidized
Satin Bronze



US26D / 626
Satin Chrome



US19 / BLK / 622
Matte Black Coated

