

Grade 3 Knob Locks 00 Series

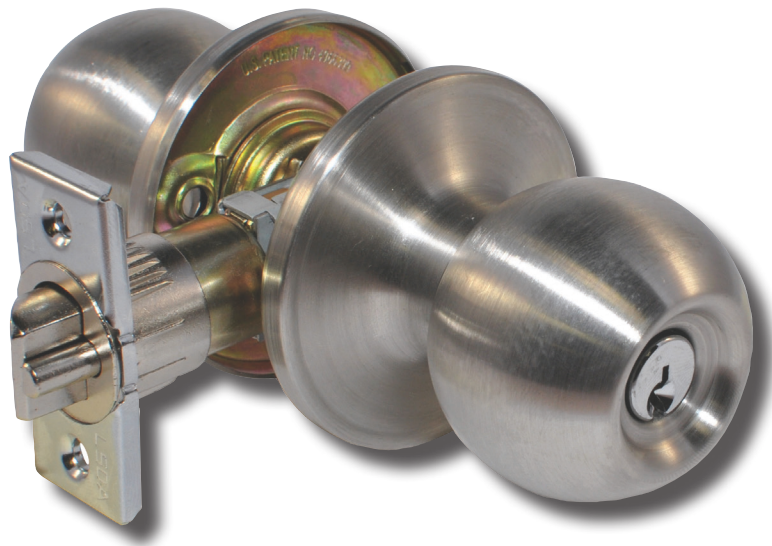

Overview

The 00-Series door knobs are residential grade tubular locks. Available in three keyways and various finishes, they can be used in most residential applications. These locks are recommended for use on exterior and interior doors.

Compliance

- ANSI/BHMA 156.2 Series 4000, Grade 3

Applications

- Houses
- Apartments



Grade 3 Knob Locks, 00 Series

Standard Features:

Latch	Adjustable 2 ³ / ₈ " and 2 ³ / ₄ " Backset
Handing	Non-Handed
Materials	Brass, Stainless steel, Steel
Strike	2 ¹ / ₄ " full lip
Door Prep	2 ¹ / ₈ " diameter bore x 1" crossbore; 2 ¹ / ₄ " x 1" latch face
Door Thickness	1 ³ / ₈ " - 1 ³ / ₄ " standard
Rose Diameter	2 ¹⁹ / ₃₂ "
Keying	Available in KW1, WR5, or SC1; Rekeyable 5-pin; Keyed Alike (KA4) in fours

Grade 3 Knob Locks, 00 Series

Designs



Ball Design
Entrance Function
Shown in 3 Finish

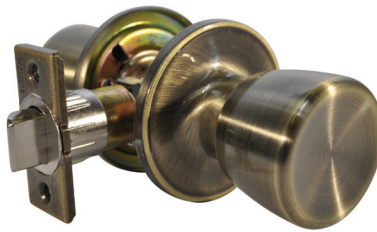

Tulip Design
Passage Function
Shown in 5 Finish

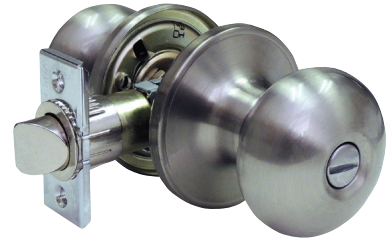

Plymouth Design
Privacy Function
Shown in 15 Finish

Functions

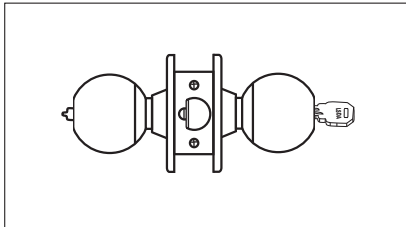

Entry

Turning inside turnpiece locks both knobs requiring use of key until turn-piece is manually unlocked.

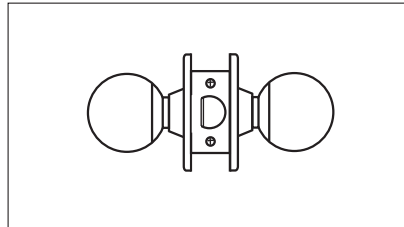

Passage/Hall/Closet

Both knobs always retract the latch.

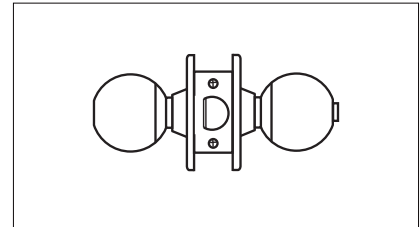

Privacy/Bed/Bath

Turning inside turnpiece locks both knobs until turnpiece is manually unlocked. Emergency tool can be used to unlock outside knob.

Grade 3 Knob Locks, 00 Series

How to Order

Entrance Locksets

Ball Design

Mfr.#	Design	Finish	Keyway	EZ#
00B3K KA4	Ball	3	KW1	100459
00B3S KA4	Ball	3	SC1	070161
00B3W KA4	Ball	3	WR5	100465
00B32D K KA4	Ball	32D	KW1	100464
00B32D S KA4	Ball	32D	SC1	070158
00B5S KA4	Ball	5	SC1	070164
00B11P K KA4	Ball	11P	KW1	109773
00B11P S KA4	Ball	11P	SC1	109774

Tulip Design

Mfr.#	Design	Finish	Keyway	EZ#
00G3K KA4	Tulip	3	KW1	009691
00G3S KA4	Tulip	3	SC1	102670
00G3W KA4	Tulip	3	WR5	041128
00G32D S KA4	Tulip	32D	SC1	102671
00G32D K KA4	Tulip	32D	KW1	009692
00G32D W KA4	Tulip	32D	WR5	045335
00G5K KA4	Tulip	5	KW1	009693
00G5W KA4	Tulip	5	WR5	041129

Plymouth Design

Mfr.#	Design	Finish	Keyway	EZ#
00P3S KA4	Plymouth	3	SC1	103539
00P3K KA4	Plymouth	3	KW1	109617
00P15S KA4	Plymouth	15	SC1	109618
00P15K KA4	Plymouth	15	KW1	109619
00P11P S KA4	Plymouth	11P	SC1	109620
00P11P K KA4	Plymouth	11P	KW1	109621
00P19W KA4	Plymouth	19	WR5	181678
00P19S KA4	Plymouth	19	SC1	182323
00P19K KA4	Plymouth	19	KW1	182322

Passage Locksets

Ball Design

Mfr.#	Design	Finish	EZ#
01B32D	Ball	32D	070160
01B3	Ball	3	070163

Tulip Design

Mfr.#	Design	Finish	EZ#
01G3	Tulip	3	009699
01G32D	Tulip	32D	009700
01G5	Tulip	5	009701

Plymouth Design

Mfr.#	Design	Finish	EZ#
01P3	Plymouth	3	103540
01P11P	Plymouth	11P	109622
01P15	Plymouth	15	109623
01P19	Plymouth	19	181679

Privacy Locksets

Ball Design

Mfr.#	Design	Finish	EZ#
02B3	Ball	3	070162
02B32D	Ball	32D	070159

Tulip Design

Mfr.#	Design	Finish	EZ#
02G3	Tulip	3	009707
02G32D	Tulip	32D	009708
02G5	Tulip	5	009709

Plymouth Design

Mfr.#	Design	Finish	EZ#
02P3	Plymouth	3	103541
02P11P	Plymouth	11P	109624
02P15	Plymouth	15	109625
02P19	Plymouth	19	181680

Grade 3 Knob Locks, 00 Series

Dimensions

Ball (B)

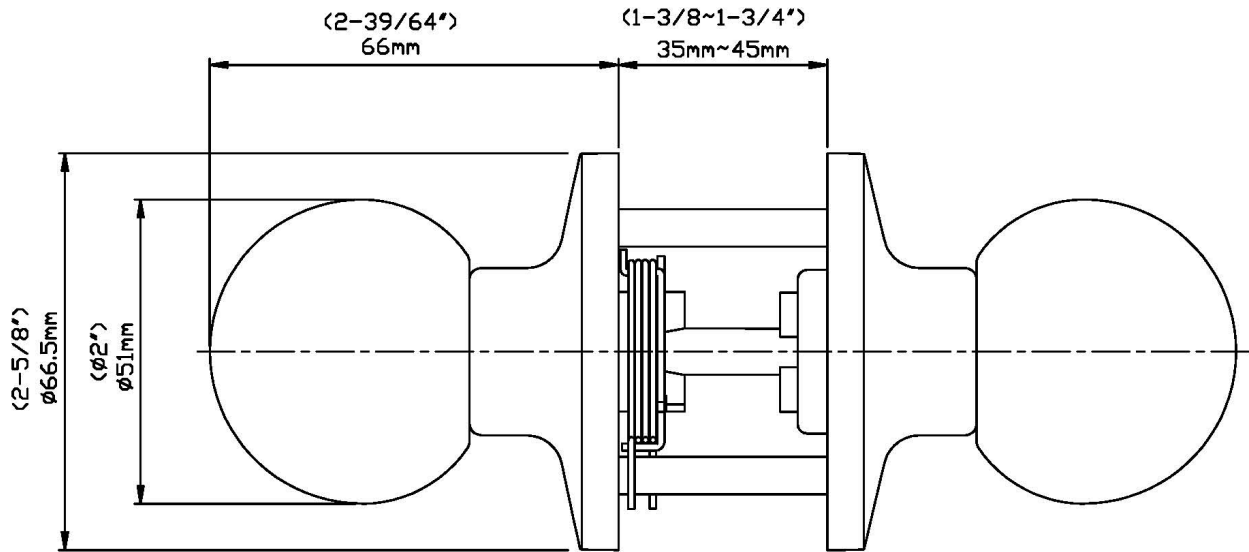

Tulip (G)

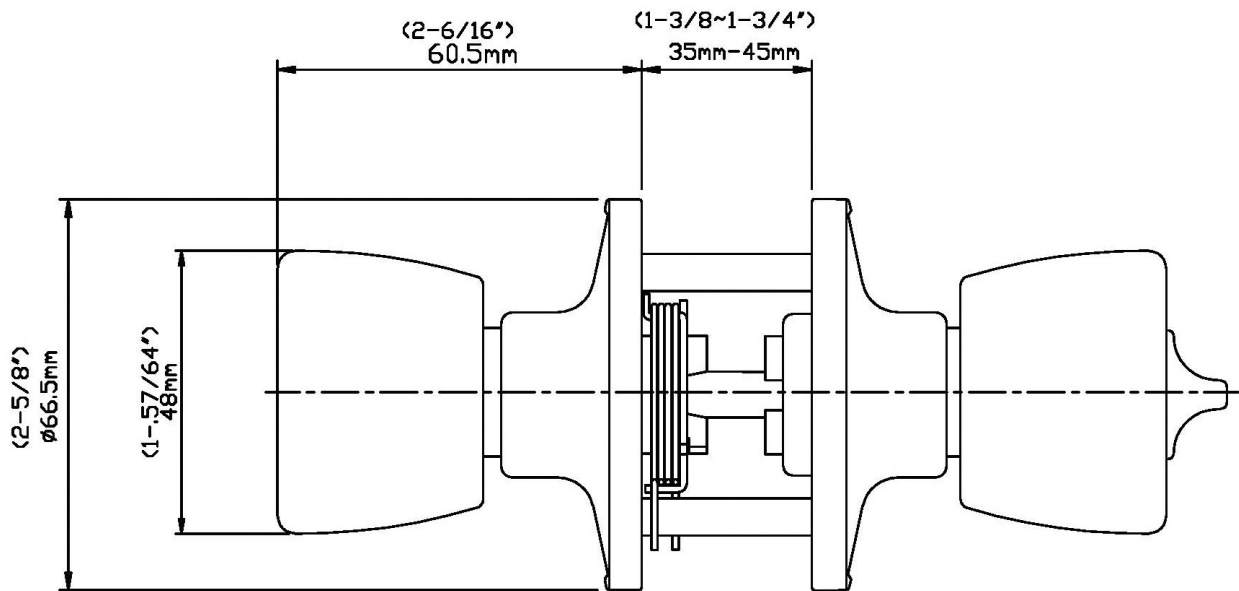

Grade 3 Knob Locks, 00 Series

Dimensions

Plymouth (P)

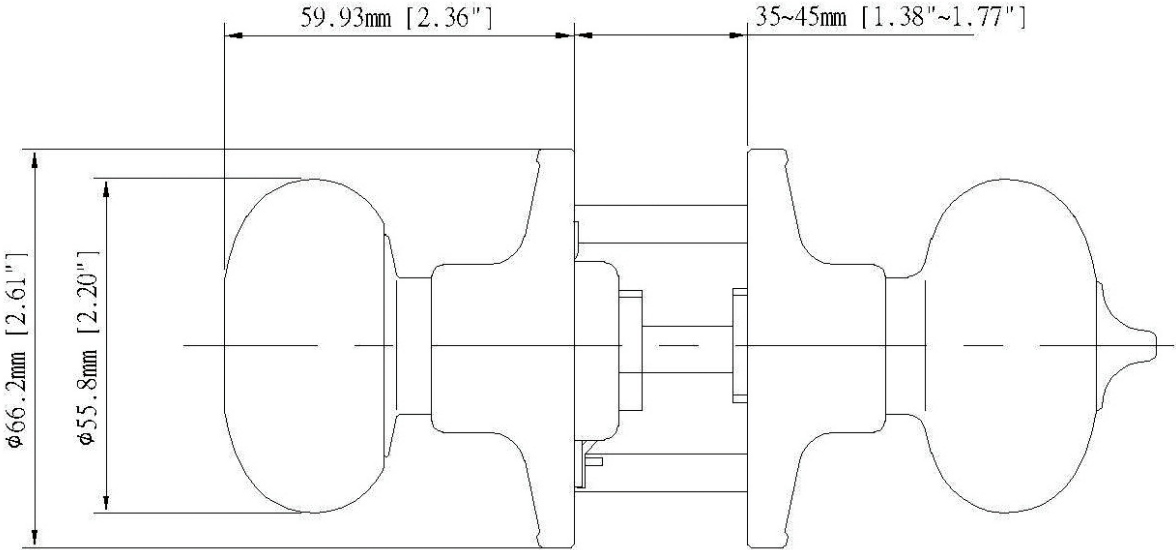

Grade 3 Knob Locks, 00 Series

Parts and Accessories



9071N

- Adjustable Deadlatches
- 2-Way Adjustable 2 $\frac{3}{8}$ " - 2 $\frac{3}{4}$ "
- $\frac{7}{8}$ " Diameter
- Finish: US3

Mfr.#	EZ#
9071N3	069245



9072N

- Adjustable Springlatch
- 2-Way Adjustable 2 $\frac{3}{8}$ " - 2 $\frac{3}{4}$ "
- $\frac{7}{8}$ " Diameter
- Finish: US3

Mfr.#	EZ#
9072N3	069246

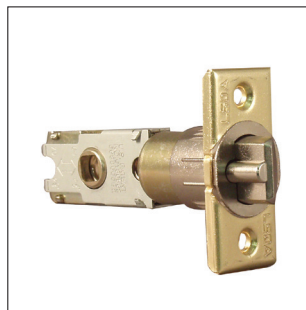

9077N

- Adjustable Deadlatches
- 4-Way Adjustable 2 $\frac{3}{8}$ " - 2 $\frac{3}{4}$ "
- 1" Diameter
- Finish: US3

Mfr.#	EZ#
9077N3	069248



9078N

- Adjustable Springlatch
- 4-Way Adjustable 2 $\frac{3}{8}$ " - 2 $\frac{3}{4}$ "
- 1" Diameter
- Finish: US3, US32D

Mfr.#	EZ#
9078N3	069251
9078N32D	069253



CYL00

- Cylinder for 00-Series
- Available in KW1, SC1, or WR3 keyway
- Drilled 5-pin, Keyed 5-pin, Keyed Different
- Finishes: Brass (BR), Chrome (CH)

Mfr.#	EZ#
CYL00W BR	103321
CYL00W CH	103322
CYL00K BR	103323
CYL00K CH	103324
CYL00S BR	103325
CYL00S CH	103326

Grade 3 Knob Locks, 00 Series

Finishes

US3 / 505 / 605
Bright Brass

A square swatch showing a bright, polished brass finish with a slight gradient from top to bottom.

US5 / 609
Antique Brass

A square swatch showing an antique brass finish with a dark, aged patina and a fine, horizontal brushed texture.

US11P / 616E
Venetian Bronze

A square swatch showing a Venetian bronze finish, which is a dark, almost black color with a subtle, curved metallic sheen.

US15 / 619
Satin Nickel

A square swatch showing a satin nickel finish with a fine, uniform brushed texture in a light, metallic tone.

US32D / 630
Satin Stainless Steel

A square swatch showing a satin stainless steel finish with a fine, vertical brushed texture in a light, metallic tone.

US19 / BLK / 622
Matte Black Coated

A square swatch showing a matte black coated finish, which is a solid, non-reflective black color.