

Grade 2 Deadbolts 220 Series

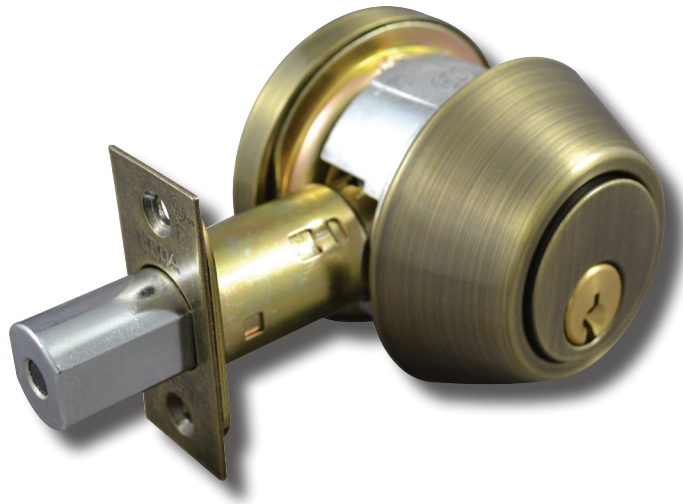

Overview

The 220-Series are heavy-duty deadbolt locks. A rugged fixed shroud surrounds the latchbolt and a free-spinning solid metal collar encases the cylinder, resisting most physical attacks. Available with SC1 or WR5 keyways or prepped for Small Format Interchangeable Core (SFIC). These locks are recommended for use on exterior and interior doors.

Compliance

- ANSI/BHMA 156.2 Series 4000, Grade 2
- Latch is UL Listed (US and Canada) for 3-hour fire doors (R15852)

Applications

- Offices
- Commercial Property
- Residences
- Multi-Family Buildings
- Industrial Sites
- Public Buildings.



Grade 2 Deadbolts, 220 Series

Standard Features:

Bolt	Adjustable 2 $\frac{3}{8}$ " to 2 $\frac{3}{4}$ " Backset Full 1" bolt projection. Drive-in latches are available.
Handing	Non-Handed
Materials	Zinc, Brass, Steel
Strike	Two strikes included: Standard Strike (1 $\frac{1}{8}$ "x 2 $\frac{3}{4}$ ", for metal frames) and Security Strike (1 $\frac{1}{8}$ "x 2 $\frac{3}{4}$ ", for wood frames, with 2 long 3" screws)
Door Prep	2 $\frac{1}{8}$ " Diameter bore, 1" crossbore Anti-pry shield
Door Thickness	1 $\frac{3}{8}$ " - 1 $\frac{3}{4}$ "
Keying	Available with WR5 or SC1, rekeyable 6-pin (keyed 5-pin) Keyed Alike (KA4) in four Compatible with many retrofit cylinders such as LSDA C500 and many high-security brands. Small Format Interchangeable Core (SFIC) is available where the lock is prepped for an SFIC cylinder 6 or 7-pin.

Grade 2 Deadbolts, 220 Series

Designs



Single Cylinder (220)
Shown in 3 Finish
Shown in SFIC



Double Cylinder (225)
Shown in 32D Finish
Shown in SC1 Keyway

Functions

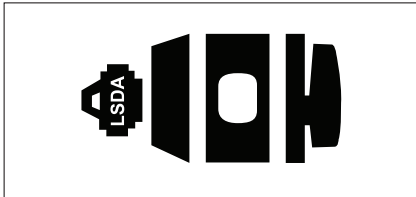

Single Cylinder

Locked or unlocked by a thumbturn inside and a key outside

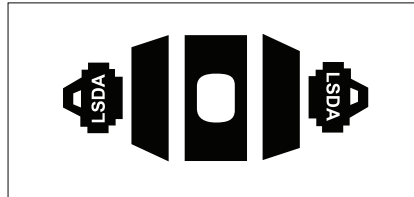

Double Cylinder*

Locked and unlocked by a key inside and outside

** Deadbolts that secure both sides of the door are controlled by building codes and the Life Safety Code. In an emergency exit situation, failure to quickly unlock the inside knob could be hazardous or even fatal.*

Grade 2 Deadbolts, 220 Series

How to Order

Single Cylinder Deadbolts

Mfr.#	Desc.	EZ#
220 32D S ADJ UL	SC1 Keyway	063538
220 3S ADJ UL	SC1 Keyway	063536
220 5S ADJ UL	SC1 Keyway	063537
220IC MB3 ADJ UL	SFIC, Less Core	085249
220IC32D ADJ UL	SFIC, Less Core	085248

Double Cylinder Deadbolts*

Mfr.#	Desc.	EZ#
225 32D S ADJ UL	SC1 Keyway	063541
225 3S ADJ UL	SC1 Keyway	063539
225 5S ADJ UL	SC1 Keyway	063540
225IC32D ADJ UL	SFIC, Less Core	085250
225IC MB3 ADJ UL	SFIC, Less Core	085251

** Deadbolts that secure both sides of the door are controlled by building codes and the Life Safety Code. In an emergency exit situation, failure to quickly unlock the inside knob could be hazardous or even fatal.*

Grade 2 Deadbolts, 220 Series

Dimensions

220-Series, IC Core

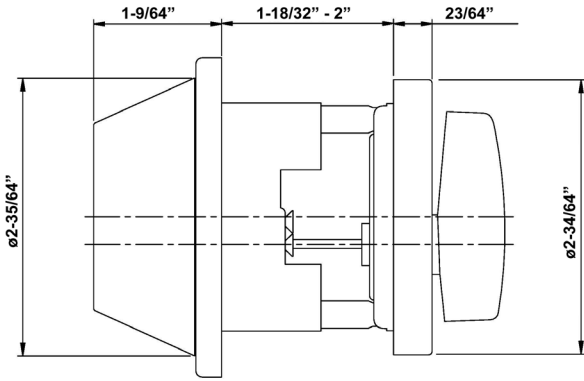

220-Series

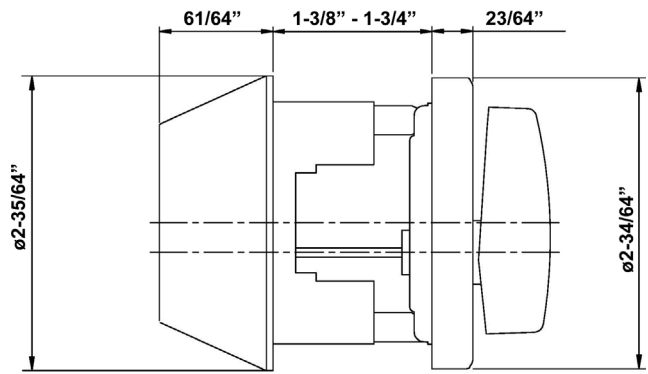

225-Series, IC Core

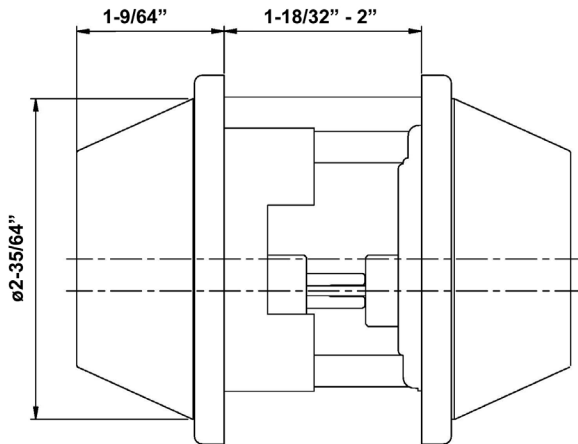

225-Series

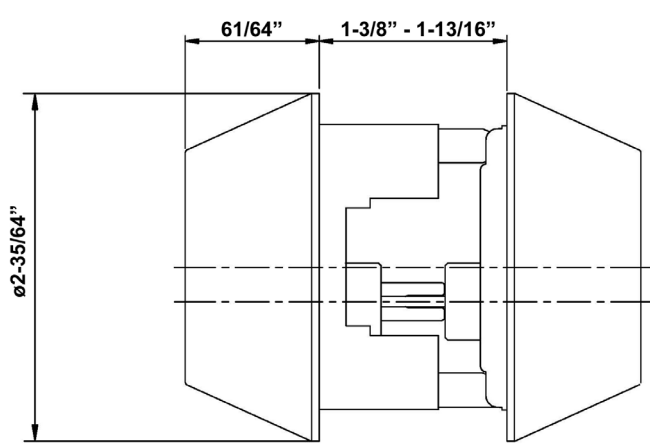

Grade 2 Deadbolts, 220 Series

Parts and Accessories



9411N

- 2" Screw Pack, Single Cylinder
- Finishes: US3

Mfr.#	EZ#
9411N 3	069268



220TDP

- 2¼" Thick Door Package, Single Cylinder
- Finishes: Brass (BR), Chrome (CH)

Mfr.#	EZ#
220TDP BR	076438
220TDP CH	076439



225TDP

- 2¼" Thick Door Package, Double Cylinder
- Finishes: Brass (BR), Chrome (CH)

Mfr.#	EZ#
225TDP BR	076440
225TDP CH	076441

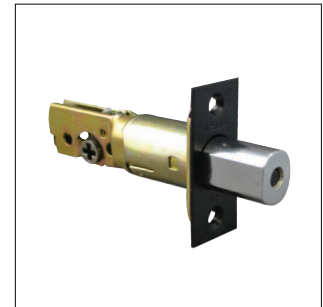

9060N

- Optional 3-Hour UL Listed Adjustable 2¾" - 2¾" Bolt
- Finishes: US32D, US3, US11P

Mfr.#	EZ#
9060N32D	080755
9060N3	080753
9060N11P	109100



9026N

- Drive-In Bolt
- Adjustable 2¾" - 2¾"

Mfr.#	EZ#
9026N	081030



9412

- Double Cylinder deadbolt tailpiece for 2" Thick Doors

Mfr.#	EZ#
9412	064856



20CAPTOOL

- 2-in-1 (12 Teeth & 14 Teeth) Cap Tool

Mfr.#	EZ#
20CAPTOOL	106804



DIT

- Inside Trim for Single Cylinder Deadbolt

Mfr.#	EZ#
DIT11P	183135
DIT15	183134
DIT3	183131
DIT32D	183132
DIT5	183133

Grade 2 Deadbolts, 220 Series

Finishes

US3 / 505 / 605
Bright Brass



US5 / 609
Antique Brass



US15 / 619
Satin Nickel



US15A / 620
Antique Nickel

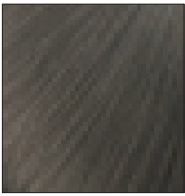

US32D / 630
Satin Stainless Steel

