

Grade 1 Lever Locks LF2000 Series

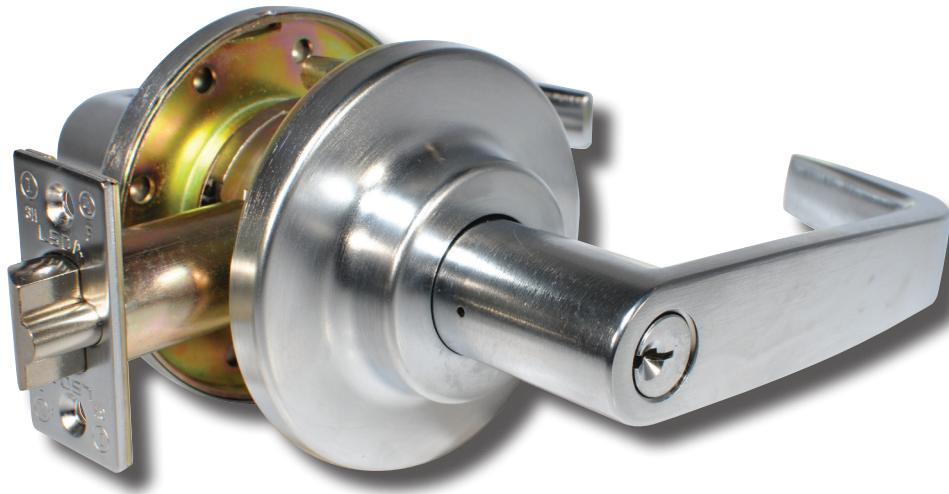

Overview

LF-Series cylindrical lever locks are designed for high traffic applications. Unique cold-rolled steel spindles withstand up to 1000 inch-pounds of torque and the lever is compliant with ADA and other accessibility codes. These locks are recommended for use on exterior and interior doors.

Compliance

- ANSI/BHMA 156.2 Series 4000, Grade 1
- Latch is UL Listed (USA and Canada, R14024) for 3-hour fire doors, included, for single swing doors (4'x8')
- ADA: The Americans With Disabilities Act (ADA) states that locks shall be operable with one hand and shall not require tight grasping, tight pinching or twisting of the wrist.

Applications

- Offices
- Hospitals
- Schools
- Multi-Family Buildings
- Industrial Sites
- Public Buildings



Grade 1 Lever Locks, LF2000 Series

Standard Features:

| | |
|-----------------------|--|
| Latch | 2¾" Backset UL Listed included; 2⅝" UL Listed Backset available |
| Handing | Non-Handed |
| Materials | Stainless Steel, Brass, Solid Die-Cast Plated |
| Strike | 4⅞" x 1⅞" ANSI |
| Door Prep | ANSI 115.2 for thru-bolted installation, 2¼" x 1⅞" latch face |
| Door Thickness | 1⅜" - 2" standard; Thick door packages are available for 2¼", Fixed Thru Bolts |
| Rose Diameter | 3½" |
| Keying | Cylinders: Equipped with SC4 rekeyable 6-pin brass cylinders, compatible with LSDA Replacement C500 cylinders and many other retrofit cylinders including most high security brands. SFIC: Some models prepped for Small Format Interchangeable Core (SFIC), such as 6- or 7-Pin Best® style cores LFIC: Some models prepped for Large Format Interchangeable Core (LFIC) such as Schlage, available in limited product selection. |

Grade 1 Lever Locks, LF2000 Series

Designs



Evanston
Entrance Function
Shown in 26D Finish



Evanston
Entrance Function, SFIC
Shown in 26D Finish



Evanston
Entrance Function, LFIC
Shown in 26D Finish

Functions

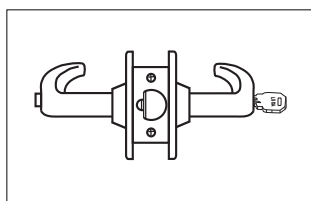

Entrance/Office

Pushing and turning inside button locks outside lever requiring use of key until button is manually unlocked. Pushing inside button locks outside lever until unlocked with a key or inside lever is turned. Inside lever always retracts latch. Available with or without Clutch.

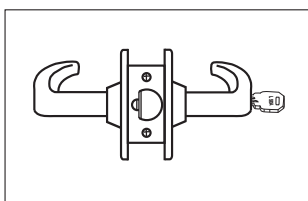

Classroom

Outside lever is locked and unlocked with a key in the outside cylinder. The inside lever always retracts the latch. Available with or without Clutch.

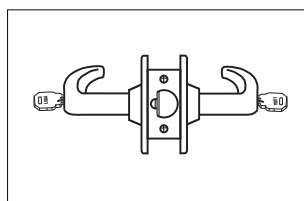

Classroom Intruder

Key in either lever locks or unlocks outside lever. Inside lever is always unlocked and free for egress. Available with or without Clutch.

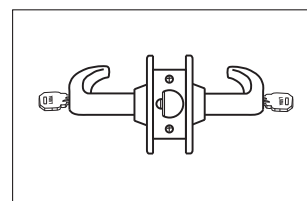

Institutional

Neither lever/knob retracts the latch. A key is required in both the inside and outside cylinder to retract the latch. Available with or without Clutch.

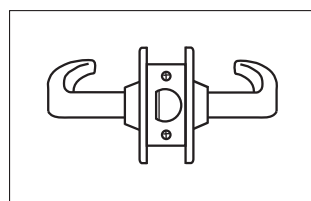

Passage

Both levers always retract the latch

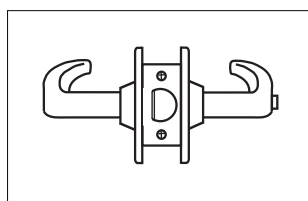

Privacy

Pushing inside button locks outside lever until inside lever is turned. Emergency tool can be used to unlock outside lever. Inside lever always retracts the latch.

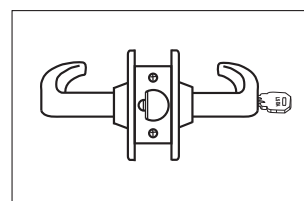

Storeroom

Outside lever never retracts the latch. Entrance by key only. Inside lever always retracts the latch. Available with or without Clutch.

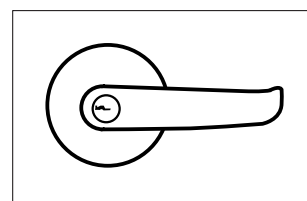

Benefits of a Clutch Lever

Clutch mechanism, or "free-wheeling" design offers an advantage over rigid locked leversets by reducing the torque applied to the outside lever

Grade 1 Lever Locks, LF2000 Series

How to Order

Entrance/Office

| Mfr.# | Desc. | EZ# |
|--------------------|----------------------|---------------|
| LF2000 26D | Entrance, SC4 Keyway | 077536 |
| LF2000IC26D | Entrance, Less SFIC | 077970 |
| LFC2000 26D | Entrance, w/Clutch | 085985 |

Passage

| Mfr.# | Desc. | EZ# |
|-------------------|---------|---------------|
| LF2100 26D | Passage | 077539 |

Privacy

| Mfr.# | Desc. | EZ# |
|-------------------|---------|---------------|
| LF2200 26D | Privacy | 077542 |

Classroom

| Mfr.# | Desc. | EZ# |
|--------------------|-----------------------|---------------|
| LF2500 26D | Classroom, SC4 Keyway | 077548 |
| LF2500IC26D | Classroom, Less SFIC | 077972 |

Storeroom

| Mfr.# | Desc. | EZ# |
|--------------------|------------------------------------|---------------|
| LF2400 26D | Storeroom, SC4 Keyway | 077545 |
| LF2400IC26D | Storeroom, Less SFIC | 077971 |
| LFC2400 26D | Storeroom, w/Clutch, SC4 Keyway | 085988 |

Classroom Intruder*

| Mfr.# | Desc. | EZ# |
|--------------------|---|---------------|
| LF2800 26D | Classroom Intruder, SC4 Keyway | 087925 |
| LFC2800 26D | Classroom Intruder, w/Clutch, SC4 Keyway | 087927 |

Institutional*

| Mfr.# | Desc. | EZ# |
|--------------------|---------------------------|---------------|
| LF2900 26D | Institutional, SC4 Keyway | 077551 |
| LF2900IC26D | Institutional, Less SFIC | 081703 |

* Locksets that secure both sides of the door are controlled by building codes and the Life Safety Code. In an emergency exit situation, failure to quickly unlock the inside knob could be hazardous or even fatal.

Grade 1 Lever Locks, LF2000 Series

Dimensions

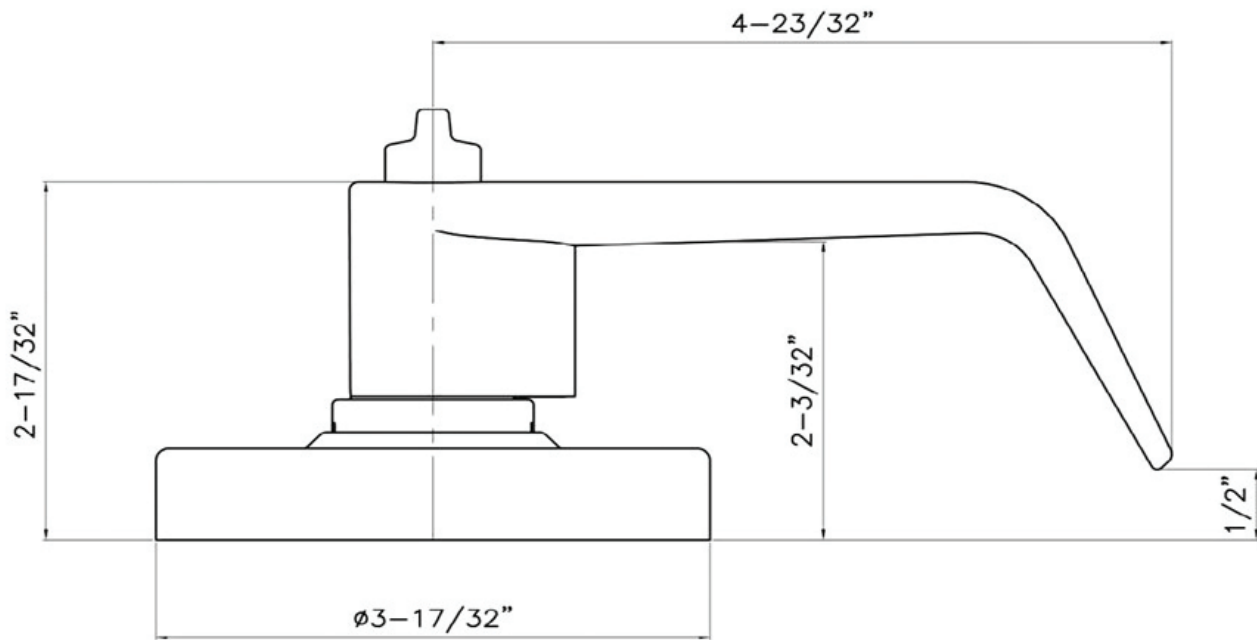

Grade 1 Lever Locks, LF2000 Series

Parts and Accessories



234DL

- Deadlatches
- 2¾" Backset, UL Listed
- Finishes: US32D

| Mfr.# | EZ# |
|----------|--------|
| 234DL32D | 009816 |



238DL

- Deadlatches
- 2¾" Backset, UL Listed
- Finishes: US26D

| Mfr.# | EZ# |
|----------|--------|
| 238DL26D | 009821 |



234SL

- Springlatches
- 2¾" Backset, UL Listed
- Finishes: US32D

| Mfr.# | EZ# |
|----------|--------|
| 234SL32D | 009819 |



TPSFIC

- Tailpiece (TPSFIC428) for SFIC, 42.8 MM for Non-Clutch (LF)
- Tailpiece (TPSFIC480) 48.0 MM for Clutch (LFC)

| Mfr.# | EZ# |
|-----------|--------|
| TPSFIC428 | 089968 |
| TPSFIC480 | 089969 |



LFTDP

- 2¼" Thick Door Kit

| Mfr.# | EZ# |
|----------|--------|
| LFTDP26D | 080706 |



5LINK

- 5" Backset extension link
- Use with 2¾" latch
- For Left Hand.

| Mfr.# | EZ# |
|-------|--------|
| 5LINK | 090846 |

Grade 1 Lever Locks, LF2000 Series

Finishes

US26D / 626
Satin Chrome

