

Grade 1 Knob Locks LH1000 Series



Overview

LH-Series cylindrical knob locks are designed for high traffic applications. Two knob designs make these an easy retrofit in many places that do not require levers for accessibility. These locks are recommended for use on exterior and interior doors.

Compliance

- ANSI/BHMA 156.2 Series 4000, Grade 1
- Latch is UL Listed (USA and Canada, R14024) for 3-hour fire doors, included

Applications

- Offices
- Hospitals
- Schools
- Multi-Family Buildings
- Industrial Sites
- Public Buildings



Grade 1 Knob Locks, LH1000 Series

Standard Features:

Latch	2 ³ / ₄ " Backset UL Listed included; 2 ³ / ₈ " UL Backset available
Handing	Non-Handed
Materials	Bronze, Brass or Stainless Steel
Strike	4 ⁷ / ₈ " x 1 ¹ / ₄ " ANSI Full Lip
Door Prep	2 ¹ / ₈ " diameter bore, 1" crossbore, 2 ¹ / ₄ " x 1 ¹ / ₄ " latch face
Door Thickness	1 ³ / ₈ " - 2" Standard; 2 ¹ / ₄ " - 2 ¹ / ₂ " thick door models are available
Rose Diameter	3"
Keying	Cylinders: Equipped with SC4 rekeyable 6-pin brass cylinders, compatible with LSDA Replacement C500 cylinders and many other retrofit cylinders including most high security brands. SFIC: Some models prepped for Small Format Interchangeable Core (SFIC), such as 6- or 7-Pin Best® style cores

Grade 1 Knob Locks, LH1000 Series

Designs

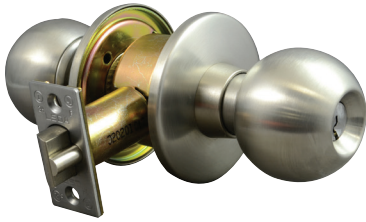

Ball (B)
Entry Function
Shown in 32D Finish

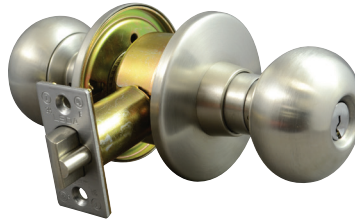

Plymouth (P)
Entry Function
Shown in 32D Finish

Functions

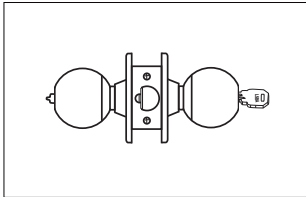

Entrance/Office

Pushing and turning inside button locks outside knob requiring use of key until button is manually unlocked. Pushing inside button locks outside knob until unlocked with a key or inside knob is turned. Inside knob always retracts the latch.

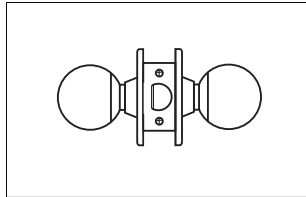

Passage

Both knobs always retract the latch.

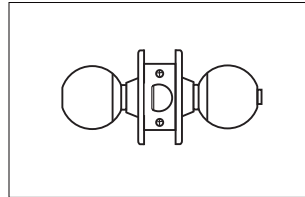

Privacy

Pushing inside button locks outside knob until inside knob is turned. Emergency tool can be used to unlock outside knob. Inside knob always retracts the latch.

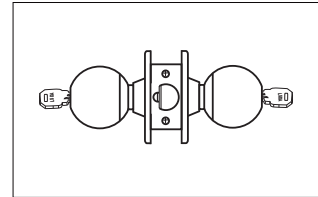

Store Door

Both knobs can be locked and unlocked with a key in either the inside or outside cylinder.

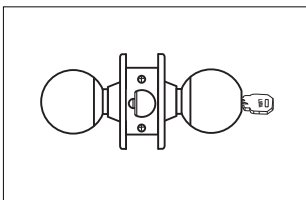

Storeroom

Outside knob never retracts the latch. Entrance by key only. Inside knob always retracts the latch.

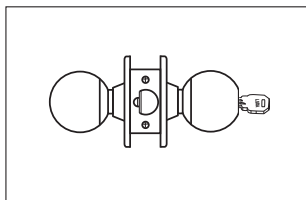

Classroom

Outside knob is locked and unlocked with a key in the outside cylinder. The inside knob always retracts the latch.

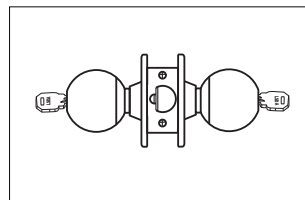

Classroom Intruder

Key in either knob locks or unlocks outside knob. Inside knob is always unlocked and free for egress.

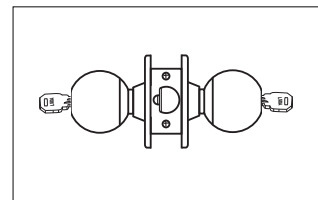

Institutional

Neither knob retracts the latch. A key is required in both the inside and outside cylinder to retract the latch.

Grade 1 Knob Locks, LH1000 Series

How to Order

Entrance/Office

Mfr.#	Desc.	Design	EZ#
LH1000B32D	SC4 Keyway	Ball	009171
LH1000B IC32D	SFIC, Less Core	Ball	091032

Passage

Mfr.#	Design	EZ#
LH1100B32D	Ball	009177

Privacy

Mfr.#	Design	EZ#
LH1200B32D	Ball	009183

Storeroom

Mfr.#	Desc.	Design	EZ#
LH1400B32D	SC4 Keyway	Ball	009195
LH1400B IC32D	SFIC, Less Core	Ball	091033

Classroom

Mfr.#	Desc.	Design	EZ#
LH1500B32D	SC4 Keyway	Ball	009201

Classroom Intruder

Mfr.#	Desc.	Design	EZ#
LH1800B32D	SC4 Keyway	Ball	091176

Institutional*

Mfr.#	Desc.	Design	EZ#
LH1900B32D	SC4 Keyway	Ball	009206
LH1900B3	SC4 Keyway	Ball	066233

* Locksets that secure both sides of the door are controlled by building codes and the Life Safety Code. In an emergency exit situation, failure to quickly unlock the inside knob could be hazardous or even fatal.

Grade 1 Knob Locks, LH1000 Series

Dimensions

Ball Design

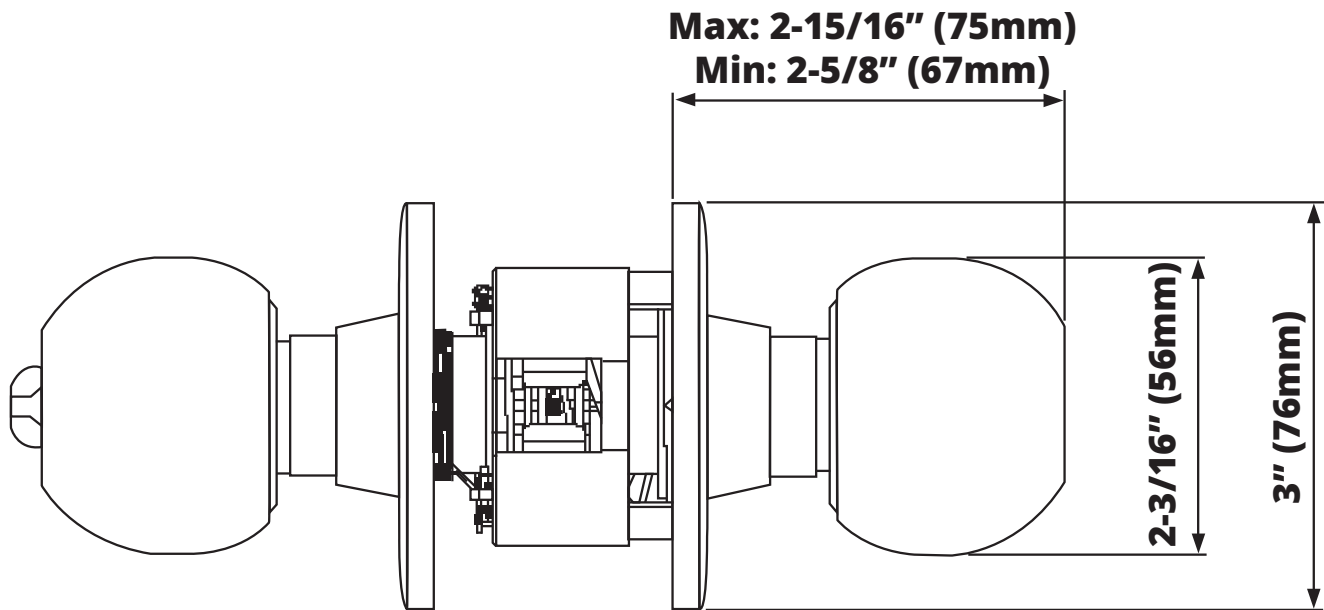

Plymouth Design

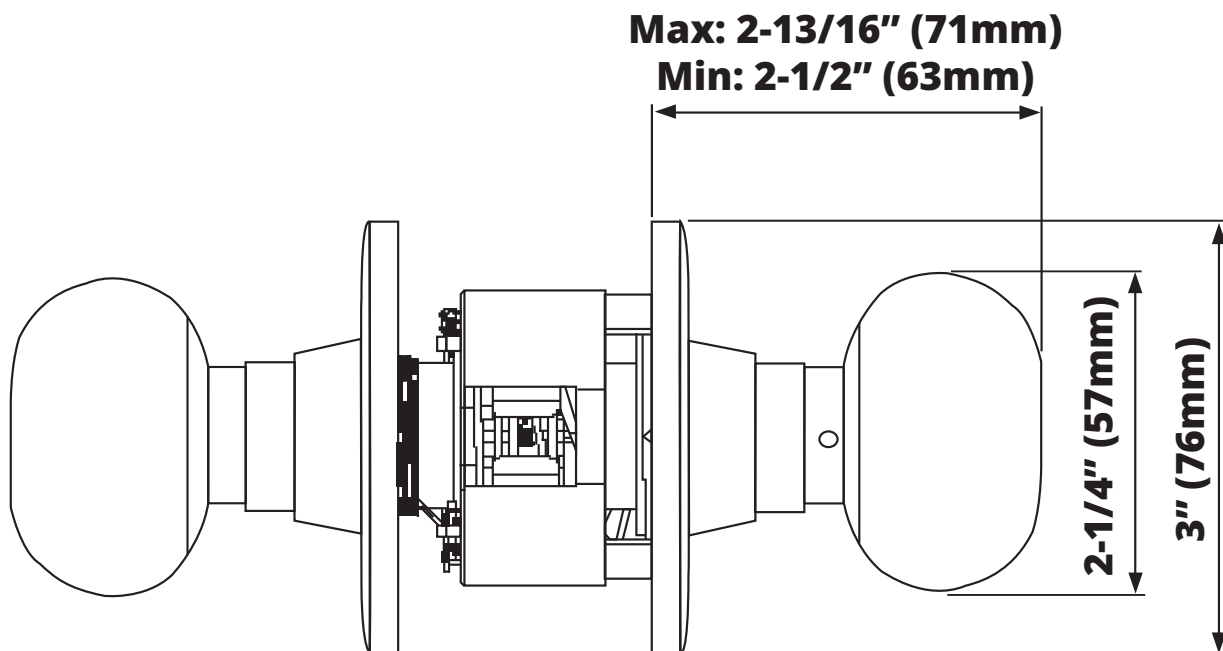

Grade 1 Knob Locks, LH1000 Series

Parts and Accessories

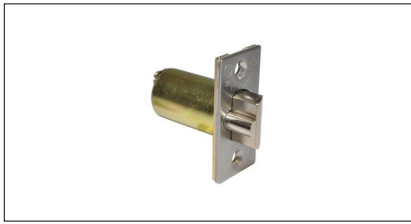

234DL

- Deadlatches
- 2¾" Backset, UL Listed
- Finishes: US32D

Mfr.#	EZ#
234DL32D	009816

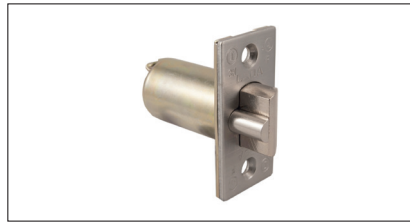

238DL

- Deadlatches
- 2¾" Backset, UL Listed
- Finishes: US26D

Mfr.#	EZ#
238DL26D	009821

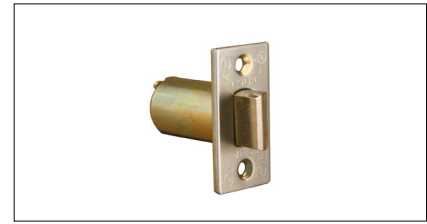

234SL

- Springlatches
- 2¾" Backset, UL Listed
- Finishes: US32D

Mfr.#	EZ#
234SL32D	009819



5LINK

- 5" Backset extension link
- Use with 2¾" latch
- For Left Hand

Mfr.#	EZ#
5LINK	090846

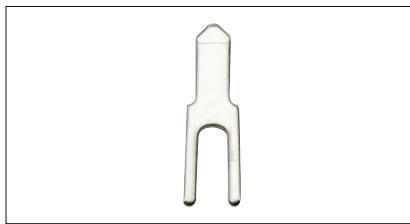

TPSFICLH

- Tailpiece for SFIC

Mfr.#	EZ#
TPSFICLH	102919

Grade 1 Knob Locks, LH1000 Series

Finishes

US3 / 505 / 605
Bright Brass



US32D / 630
Satin Stainless
Steel

